

# Mondo

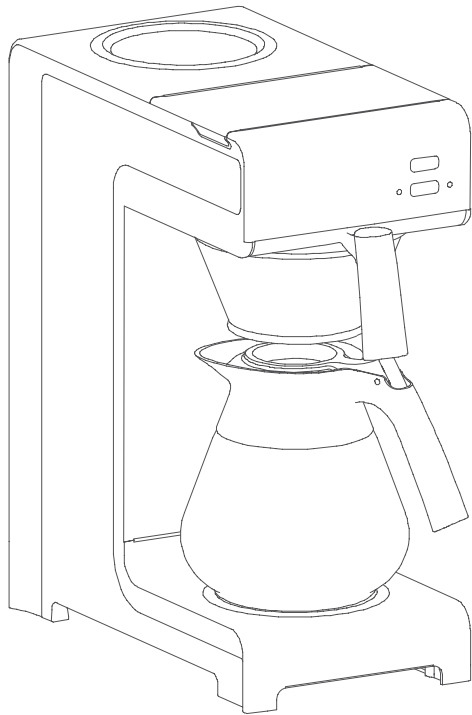

**Mondo**

User manual  
Mode d'emploi Utilisateur  
Gebraucher Handbuch  
Gebruiksaanwijzing  
Användarmanualen  
Brukerhåndbok  
Brugsanvisningen  
Käyttäjän käsikirja  
Manual del usuario  
Manual do utilizador  
Manuale per l'utente  
Εγχειρίδιο χρήσης  
Prostudujte uživatelskou  
Podręcznik użytkownika  
Manualul utilizatorului  
уководство пользователя  
Kullanıcı kılavuzu  
使用者手冊  
ユーザーマニュアル  
사용자 설명서

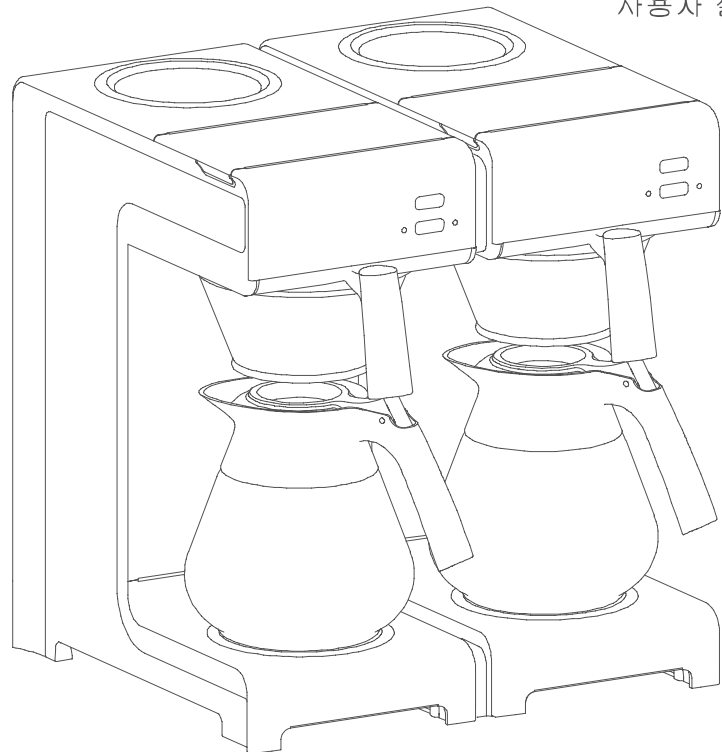

**Mondo**

**Twin**



English  
Français  
Deutsch  
Nederlands  
Svenska



Norsk  
Dansk  
Suomi  
Español  
Português

Italiano  
Ελληνικά  
Česky  
Polski  
Română



Русский  
Türkçe  
한국어  
日本語

Information  
Information  
Information  
Informatie  
Information



Informasjon  
Information  
Informaatio  
Información  
Informação

Installation  
Installation  
Installation  
Installeren  
Installation



Installasjon  
Installation  
Asennus  
Instalar  
Instalação

Handling  
Fonctionnement  
Bedienung  
Bedienen  
Handhavande



Betjene  
Betjening  
Käsittely  
Operación  
Execução

Cleaning  
Nettoyage  
Reinigung  
Schoonmaken  
Rengöring



Vasking  
Rengöring  
Puhdistus  
Limpiar  
Limpeza

Descaling  
Détartrage  
Entkalkung  
Ontkalken  
Avkalkning



Rensing  
Afkalkning  
Kalkinpoisto  
Descalcificación  
Descalcificação

Safety book  
Sommaire des sécurités  
Sicherheitsvorschriften  
Veiligheidsboek  
Säkerhetsföreskrifter



Sikkerhetsbok  
Sikkerhedsbog  
Turvallisuusohjeet  
Libro de seguridad  
Instruções de segurança

Accessories  
Accessoires  
Zubehör  
Toebehoren  
Tillbehör



Tilbehør  
Valgbar  
Lisälaitteet  
Accesorios  
Acessórios

Wait  
Patienter  
Warten  
Wachten  
Vänta



Vent  
Vent  
Odota  
Esperar  
Aguardar

Rinse  
Rinçer  
Spülen  
Afspoelen  
Sköljning



Skylle  
Rensning  
Huuhtelee  
Aclarar  
Enxaguamento

Safety gloves  
Gants de sécurité  
Schutzhandschuh  
Veiligheidshandschoenen  
Skydds handskar



Hansker  
Sikkerheds handsker  
Suojahanskat  
Zapatos de seguridad  
Luvas de protecção

Safety goggles  
Lunettes de sécurité  
Schutzbrille  
Veiligheidsbril  
Skydds glasögon



Vernebriller  
Sikkerhedsbriller  
Suojalasit  
Gafas de seguridad  
Óculos de protecção

Dishwasher proof  
Lave-vaisselle autorisé  
Geschirrspülertauglich  
Vaatwasmaschine  
bestandig  
Tål maskindisk



Tåler oppvaskmaskin  
Maskinopvaske bestandig  
Astianpesukoneen kestävä  
Rest. para lavaplatos  
À prova de máquina de lavar  
louça

Moist cloth  
Chiffon humide  
Feuchtes Tuch  
Vochtige doek  
Fuktig trasa



Fuktig klut  
Fugtig klud  
Kosteaa pyyhe  
Trapo húmedo  
Pano húmido

Informazione  
Πληροφορίες  
Informace  
Informacja  
Informație



Информация  
Bilgi  
資料  
情報  
알림

Installazione  
Εγκατάσταση  
Instalace  
Instalacja  
Operare



Установка  
Yerleştirme  
安裝  
設置  
설치

Istruzione d'uso  
Χειρισμός  
Obsluha  
Instrukcja obsługi  
Instalare



Обслуживание  
Kullanım  
操作  
取り扱い  
취급

Pulizia  
Καθαρισμός  
Čištění  
Czyszczenie  
Curățare



уистка  
Temizleme  
清洗  
洗淨  
청소

Decalcificazione  
Αφαλάτωση  
Odvápnění  
Odkamienianie  
Decalcarizare



уистка от накипи  
Kireçten arındırma  
除垢  
デスケール  
스케일 청소

Prescrizioni di sicurezza  
Έντυπο ασφαλείας  
Bezpečnostní kniha  
Wskazówki bezpieczeństwa  
Carte instructaj



Инструкция по эксплуатации  
Güvenlik kitabı  
安全冊子  
安全説明書  
안전 지침서

Accessori  
Εξαρτήματα  
Příslušenství  
Akcesoria  
Accesorii



Аксессуары  
Akcesuarlar  
附件  
備品  
악세서리

Attendere  
Αναμονή  
Čekejte  
Czekaj  
Așteaptă



Ждите  
Bekle  
等候  
待つ  
기다림

Lavaggio  
Ελαφριά πλύση  
Vypláchnout  
Płukanie  
Clătire



Прополоскать  
Durula  
沖洗  
すすぐ  
세척

Guanti di protezione  
Γάντια ασφαλείας  
Ochranné rukavice  
Rękawiczki ochronne  
Mănuși protecție



Защитные перчатки  
Güvenlik eldivenleri  
安全手套  
安全手袋  
안전용 장갑

Occhiali di protezione  
Γυαλιά ασφαλείας  
Ochranné brýle  
Okulary ochronne  
Ochelari protecție



Защитные очки  
Güvenlik gözlükleri  
護目鏡  
安全眼鏡  
안전용 안경

Idoneo per lavastoviglie  
Εγγυημένο για χρήση σε  
πλυντήριο πιάτων  
Myčka –důkaz  
Mycie w zmywarce  
dozwolone  
Spälåtor veselä



Допускается Ристка в  
посудомоеРной машине  
Bulaşık makinası uyumlu  
可放於洗碗碟機清洗  
食器洗い機で使用可能  
접시세척기 사용금지

Panno umido  
Υγρό πανί  
Vlhká látka  
Wilgotna szmatka  
Cârpă umedă



Влажная салфетка  
Nemli bez  
濕布  
濕った布  
젖은헝겂

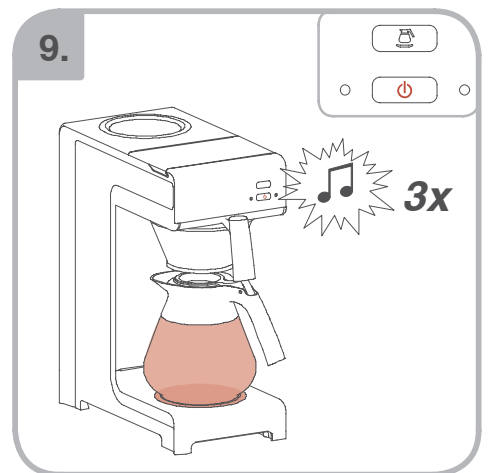
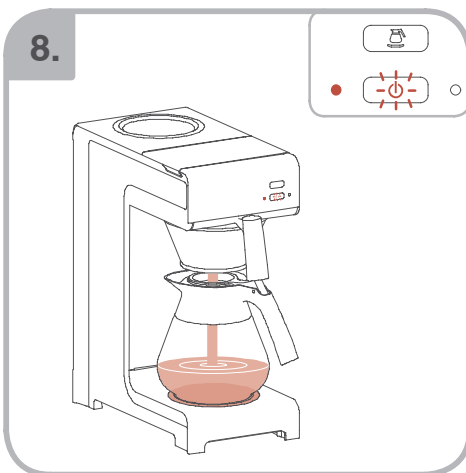
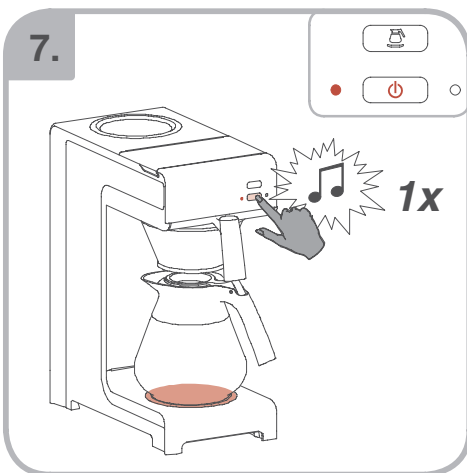
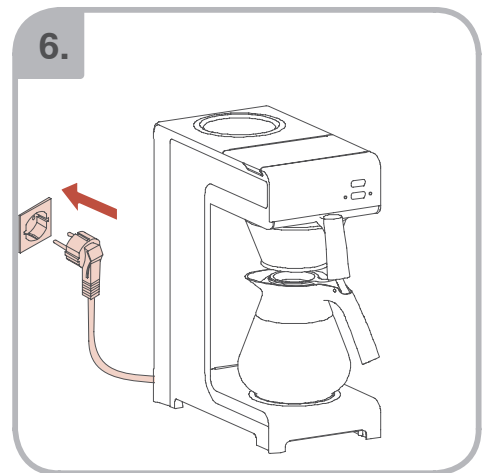
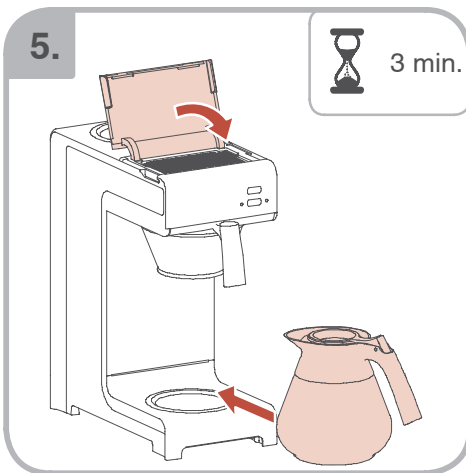
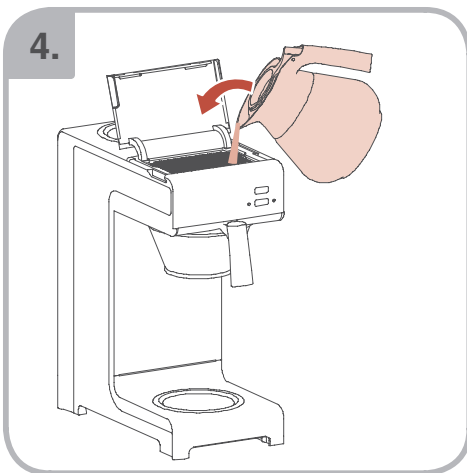
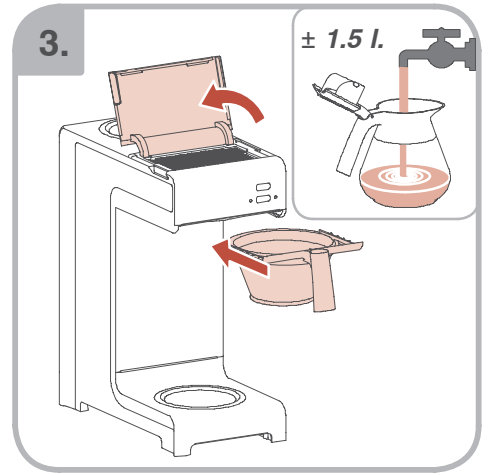
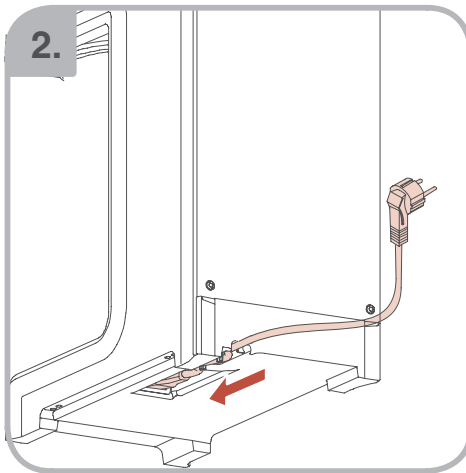

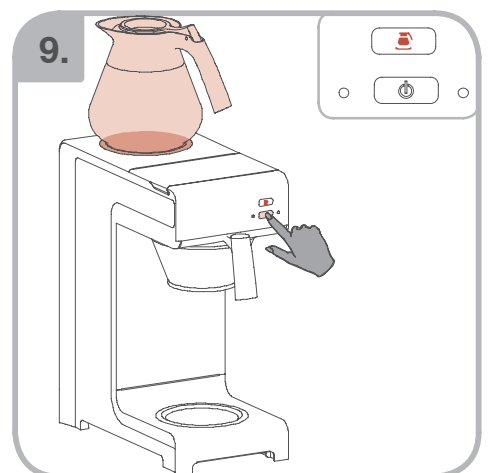
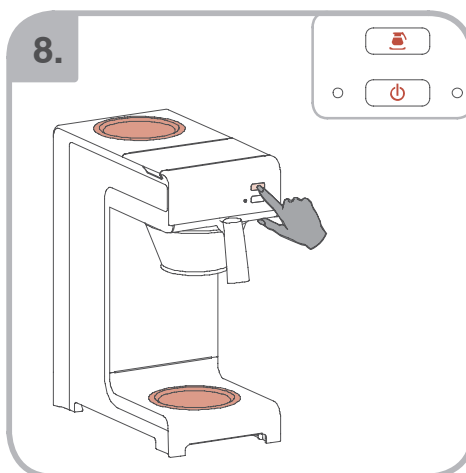
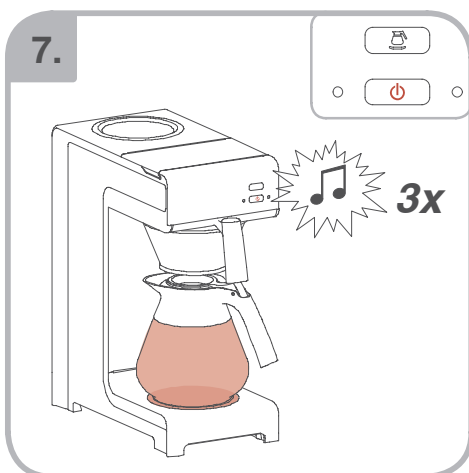
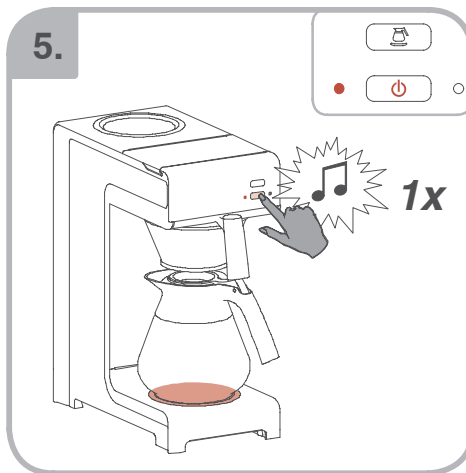
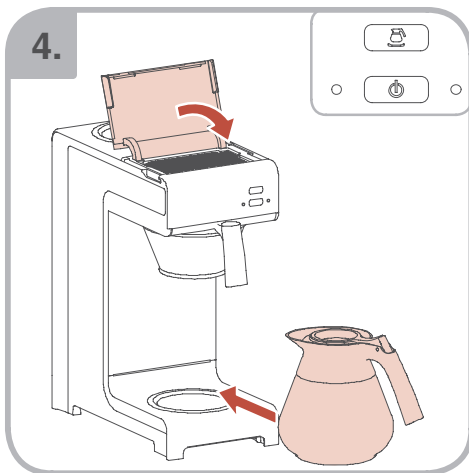
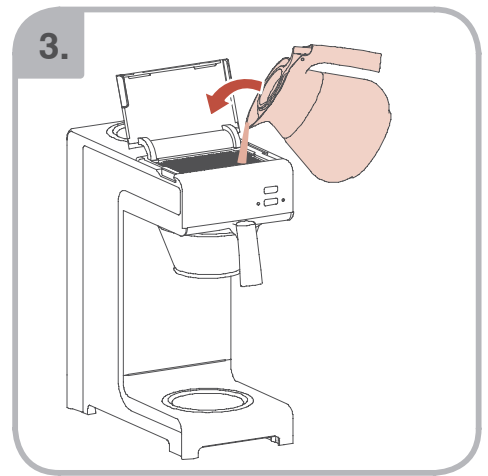
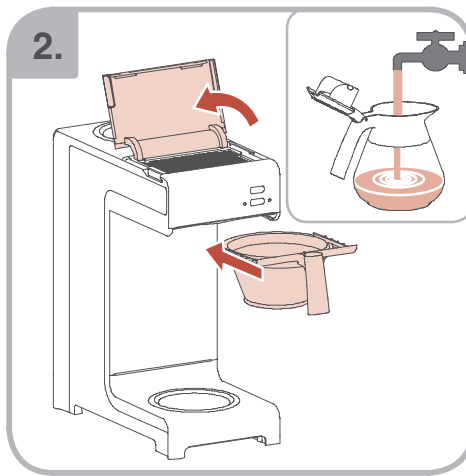
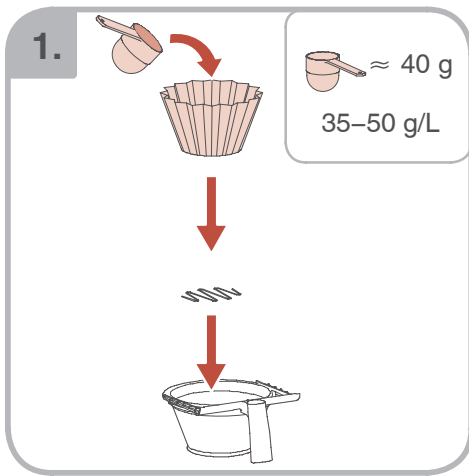

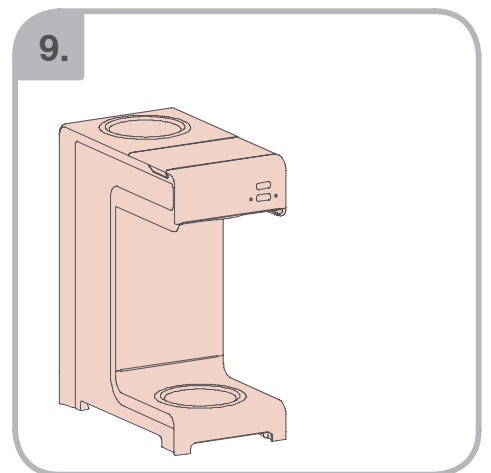
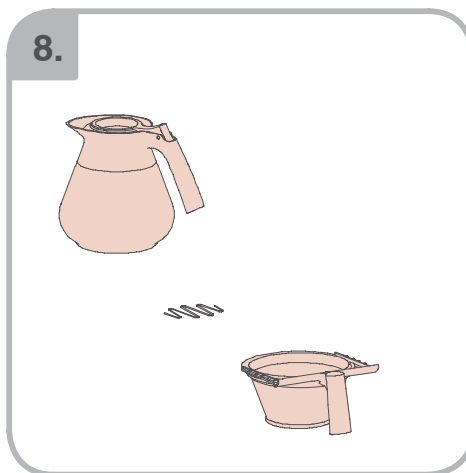
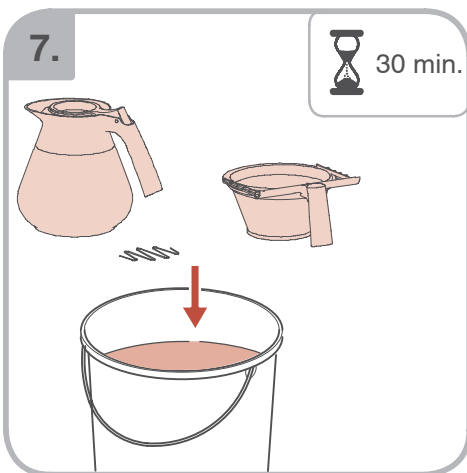
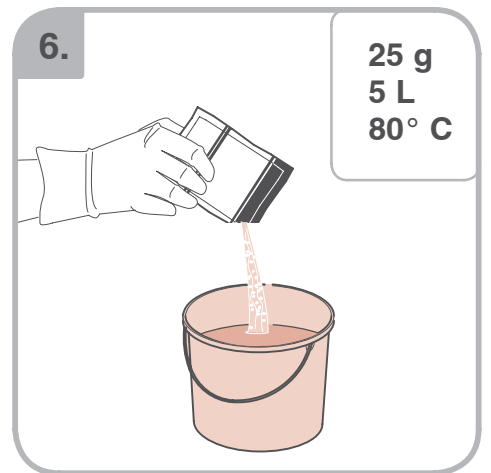
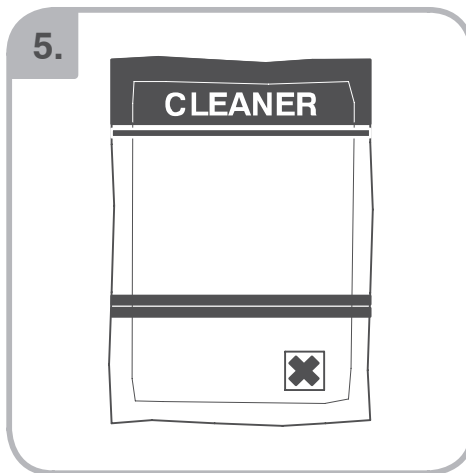
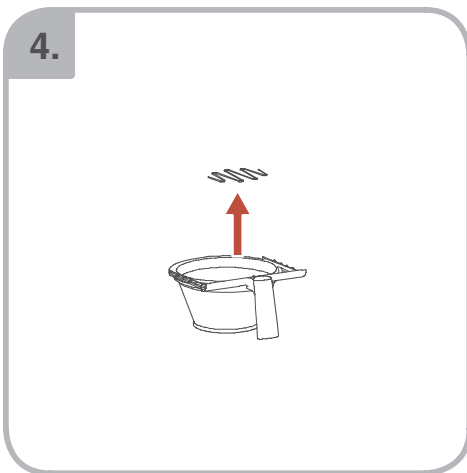
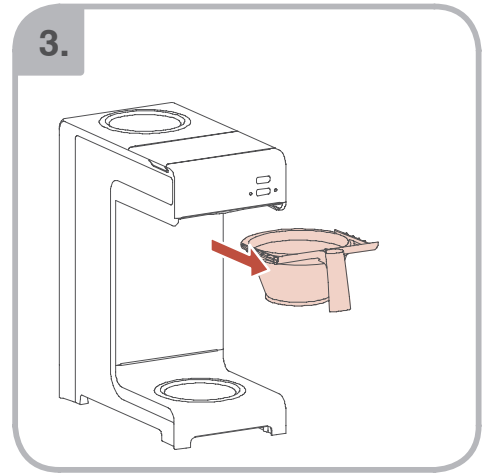
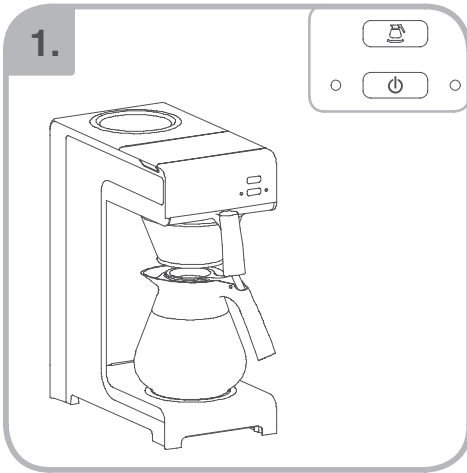



10.

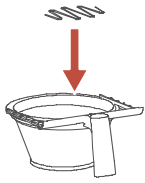

11.

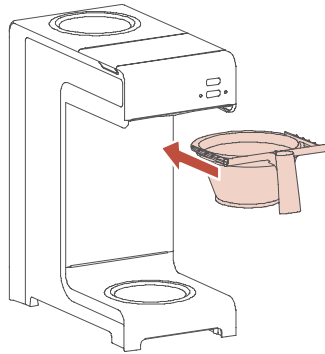

12.

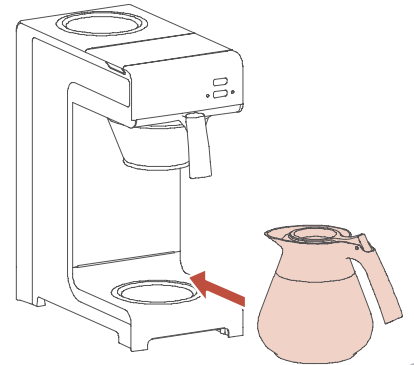

13.

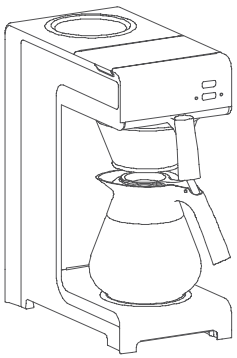

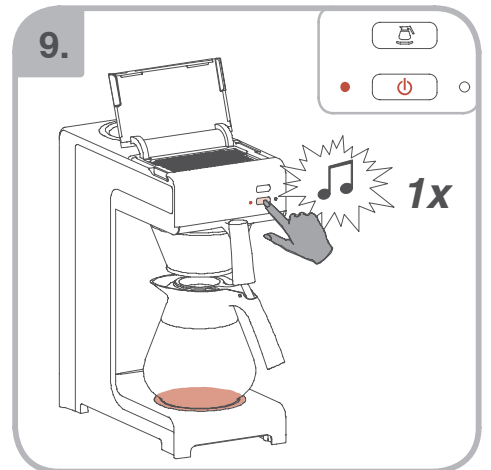
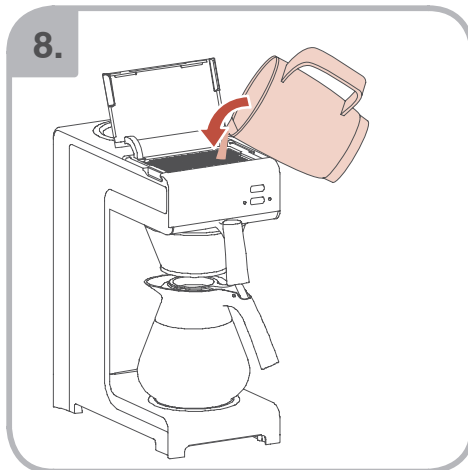
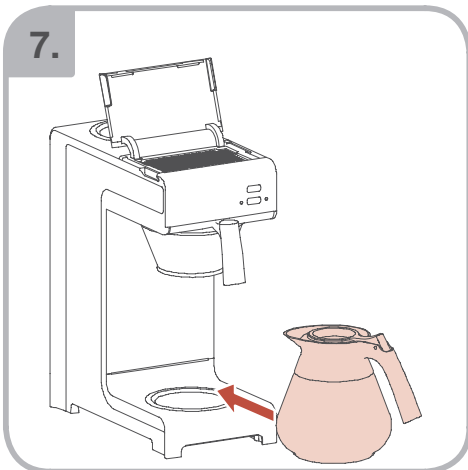
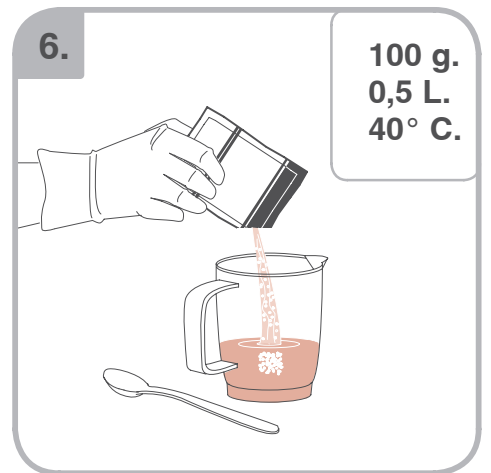
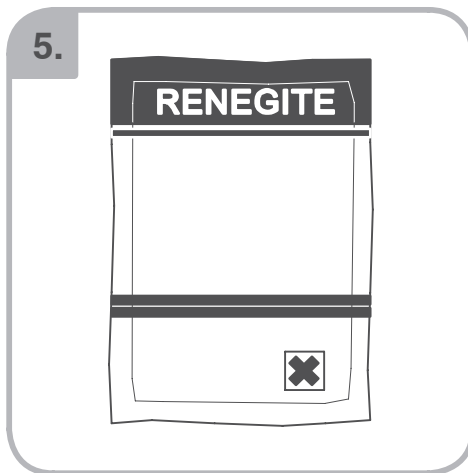
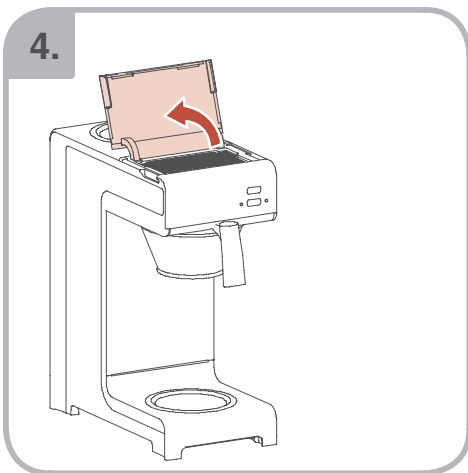
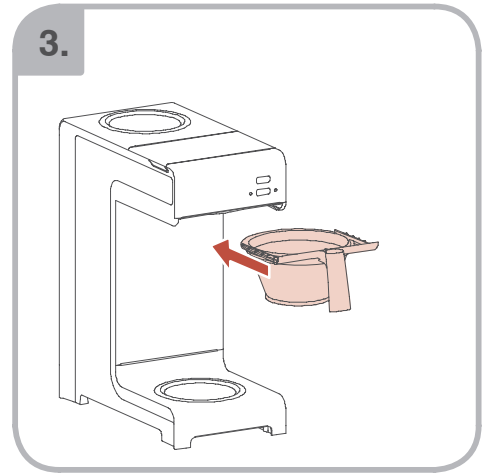
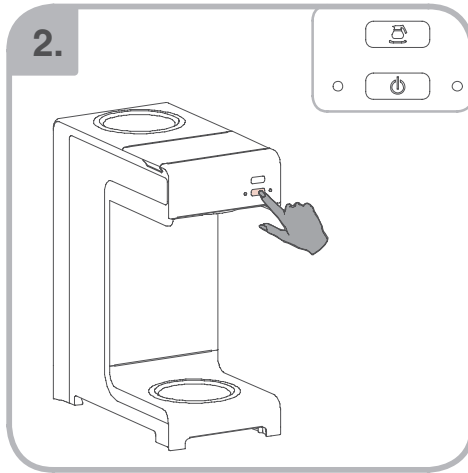
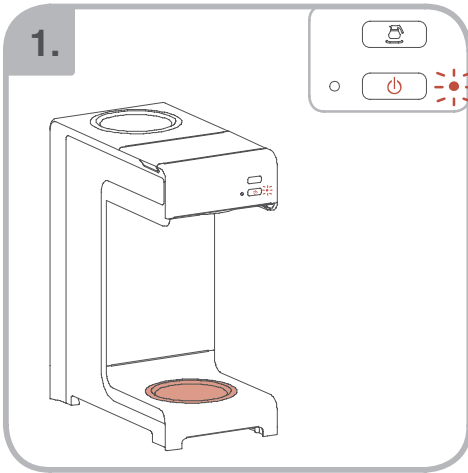

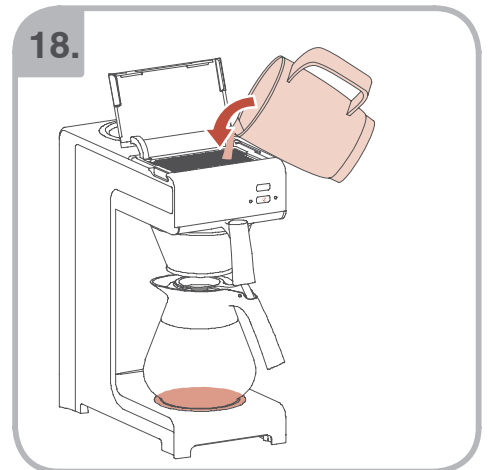
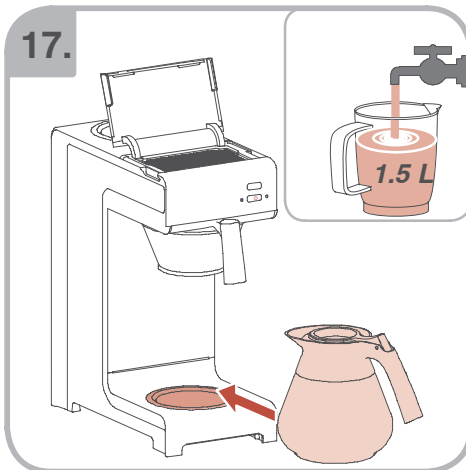
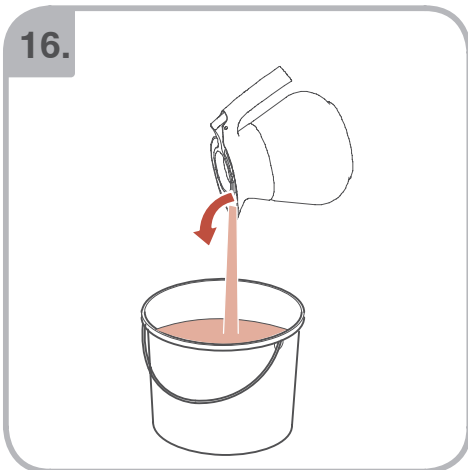
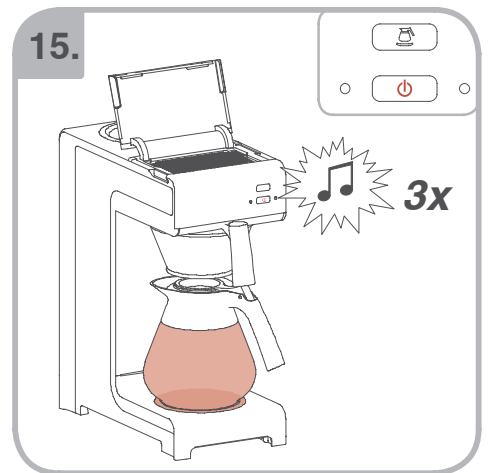
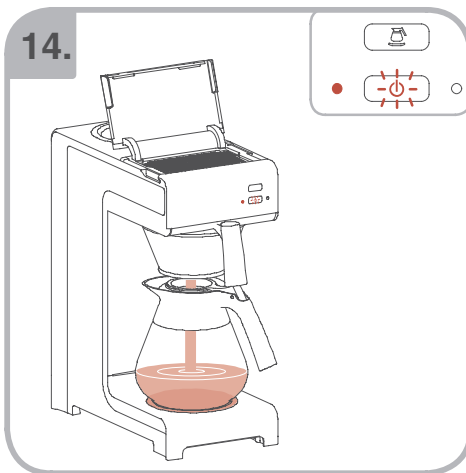
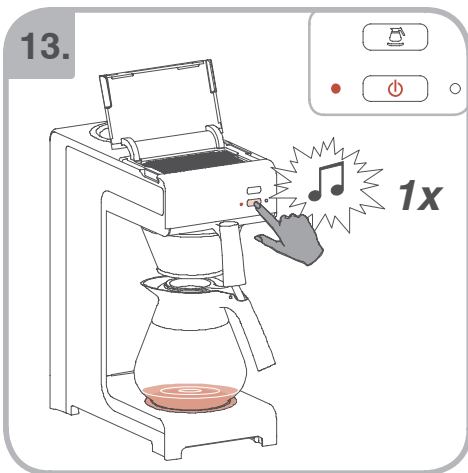
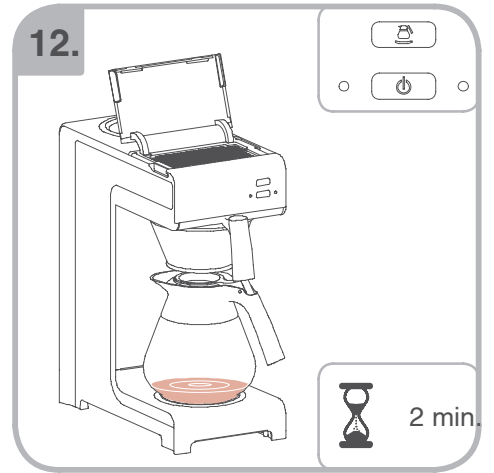
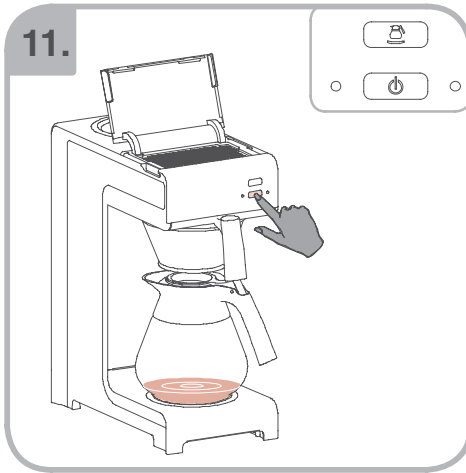
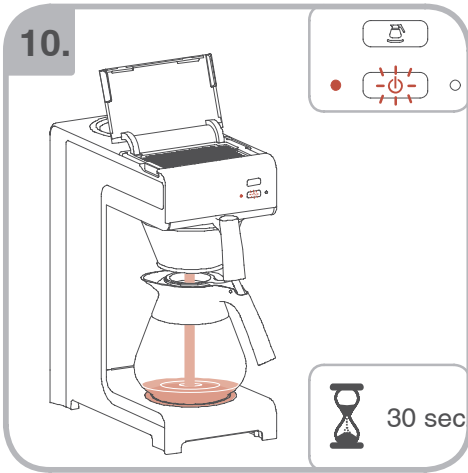



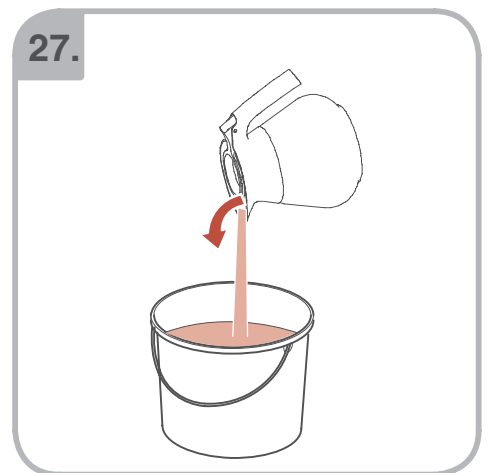
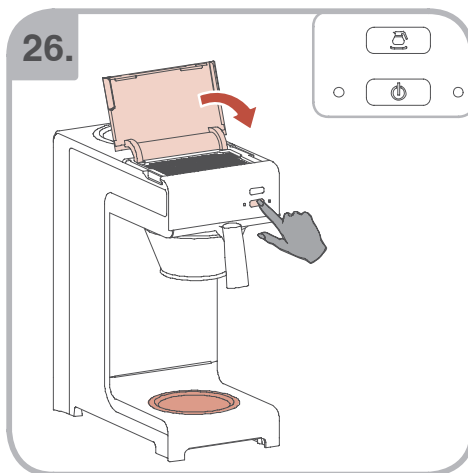
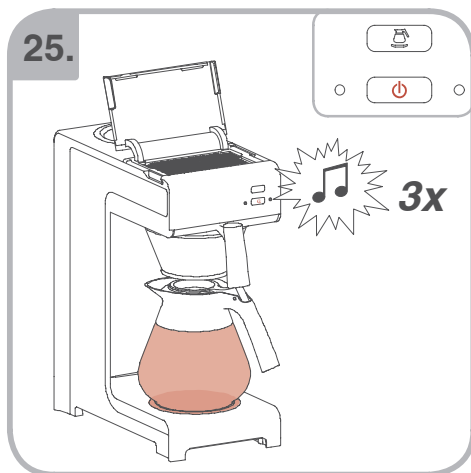
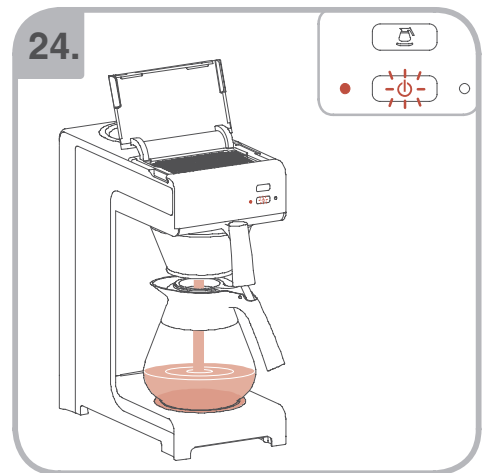
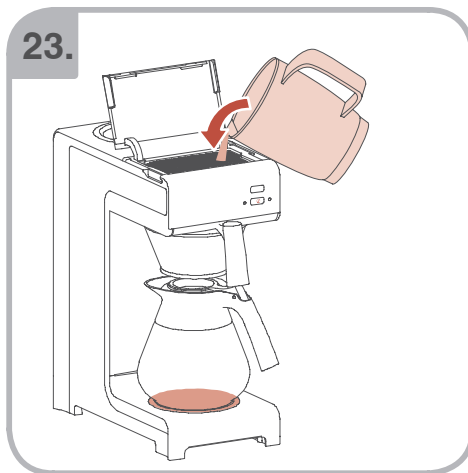
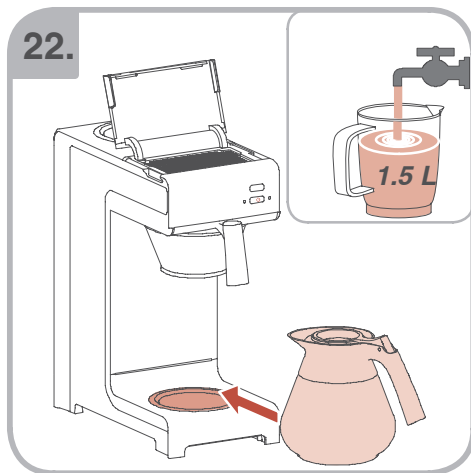
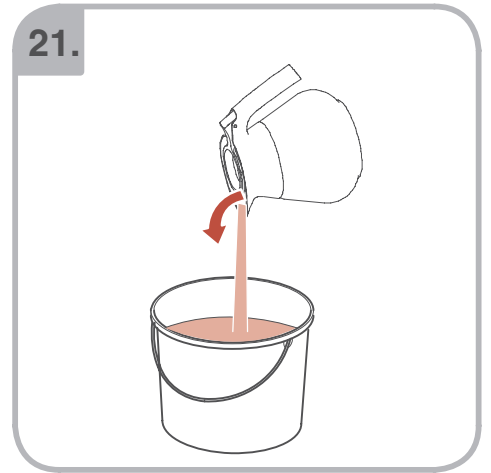
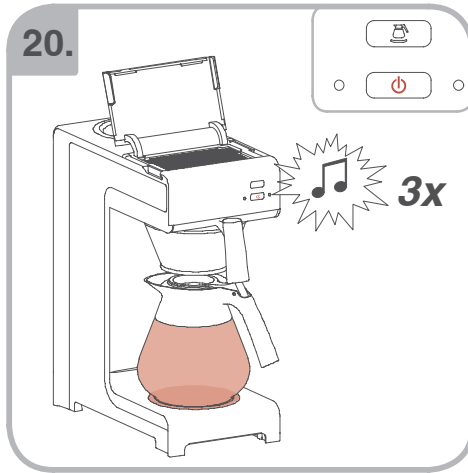
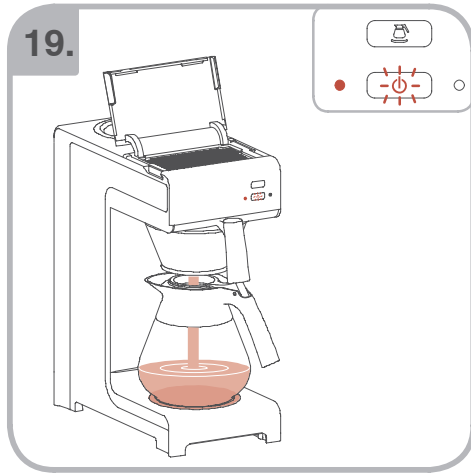

# Mondo

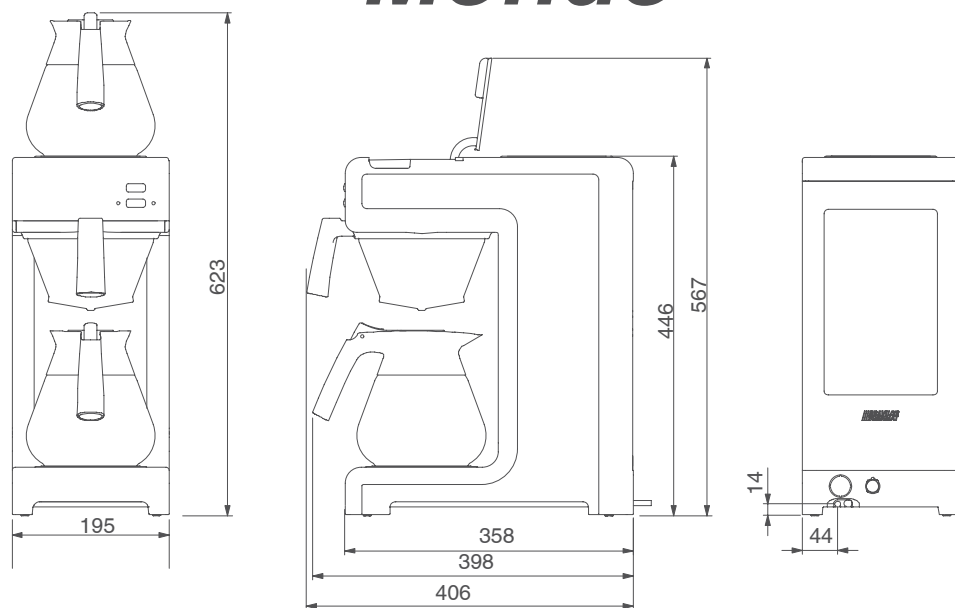

# Mondo Twin

